

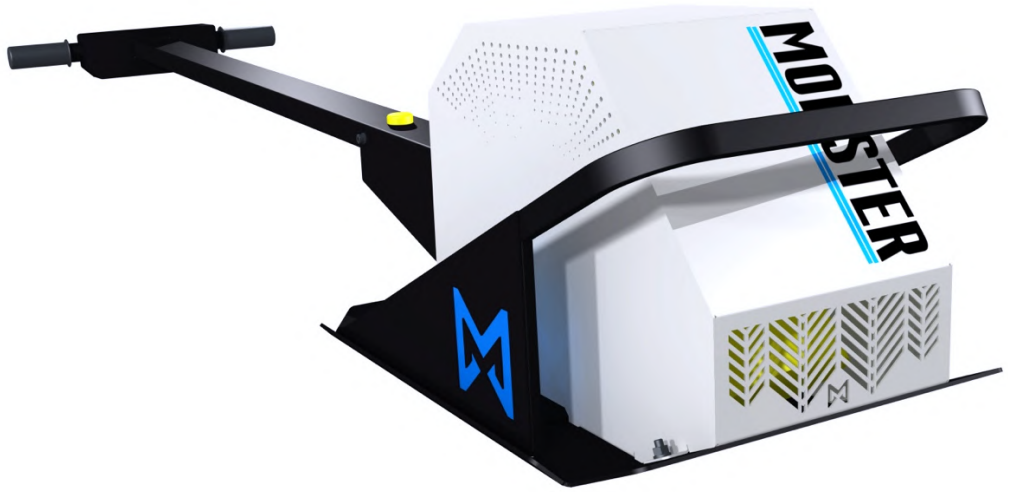

USER MANUAL

MONSTER HIGH POWER LASER SLAT CLEANER

2024_V1



DORAY MAKİNA SAN. VE TİC. TLD. ŞTİ.
Alaaddinbey Mah. 637. Sokak
İşyerleri Sitesi No:7/1
NİLÜFER – BURSA – TÜRKİYE
Phone: +90 224 413 2182
info@doraymakina.com
www.doraymakina.com

SAFETY	3
GENERAL DESCRIPTIONS	4
1. DESCRIPTIONS	4
2. ADVANTAGES OF MONSTER SLAG CLEANER	5
3. TECHNICAL SPECIFICATIONS	6
BEFORE USAGE OF MONSTER	7
1. UNBOXING	7
2. ASSEMBLING THE CONTROLLING ARM	8
3. WHEEL STAND TAKE OFF / FIXATE	9
WORKING WITH THE MONSTER	10
1. SWITCHING ON THE MONSTER	10
2. OPERATING / CLEANING WITH THE MONSTER	12
3. SWITCHING OFF THE MONSTER	14
4. MOTOR OVERLOAD PROTECTION	15
MAINTENANCE	16
1. REPLACING THE BREAKERS	16
2. REPLACING THE UNDER BODY COVER PLATE	17
3. REPLACING THE CARBON BRUSHES	18
4. ELECTRICAL SCHEMA OF MONSTER	19
CONSUMABLES	20
EU DECLARATION OF CONFORMITY	21
CE CERTIFICATE	22
WARRANTY LETTER	23



- > Before usage, please **read all the described risk & safety & warnings carefully.**
- > Failure of following the safety instructions of this document may cause electric shock, burns and/or serious injury.
- > Keep this manual and all the instructions for future use.



- > Disconnect the plug before any kind of operation.
- > Machine working voltage is 220 VAC – monophase.
- > Before performing maintenance on MONSTER, unplug the tool from power.
- > Do not connect the tool to the mains during maintenance. This can even cause death!



- > Wear safety glasses, hearing protection and protective footwear when working with the machine at all time.
- > It is recommended to wear protective clothes, dust mask and gloves.



- > Machine must not be operated before putting on the slats.
- > Use Front Handling Bar to put the machine on the slats. 2 Persons can handle the machine together if needed.
- > Push buttons are for safe use, it needs to be pushed two of them at the same time. Machine will not work if one of the buttons only be pushed.
- > Power cable must be kept clear from working range of the machine. Always keep the cable away from the machine.
- > If the supply cable is damaged, it must be replaced by only qualified personnel.
- > The ventilation slots must be kept clear, otherwise it may cause overheating.
- > Switch OFF the machine after usage and then pull the supply cable.
- > Take the machine floor after usage and be sure to screw the wheel stand tightly then it will be safe to stock the machine in standing position.
- > Do not expose the machine to wet conditions or do not operate in damp environment.

1. Descriptions

**INFO**

The purpose of the MONSTER product is to ensure easy cleaning of the metal slags accumulated on the table of the thermal (hot) cutting machines (laser).

MONSTER is recommended to be used at least once a week. By this way, lifetime of the brakers and lifetime of the slats will increase.

**WARNING**

While using the MONSTER, all rules must be followed in this User Manual. If you are using The MONSTER for the first time, you must pay attention to the points explained on the following pages at all time.

**WARNING**

Maintenance periods should be followed regularly, and the maintenance methods should be carried out carefully, as in the manual.

Only the original parts should be used when spare parts are required during usage.

Some breakers must not be used for different slat thicknesses. Please contact for the different types of breakers.

**WARNING**

Before using the MONSTER, please read carefully SAFETY & WARNINGS SECTION.



2. Advantages of MONSTER Slag Cleaner

Cutting operations on the slag-free slats, increase the quality, efficiency and cutting speed compared with the slats accumulated with slags. Hence, using The MONSTER Slag Cleaner have the below advantages versus to a manual cleaning:

- Manual cleaning takes approx. 180 – 200 minutes.
- Cleaning with MONSTER takes 20 – 30 minutes.

- Number of slat changes is 3 – 4 times per a year with Manual Cleaning.
- Number of slat changes is once in every 2 years with MONSTER. (*According to the usage*)

- Manual cleaning damages the slats.
- Lifetime of the slats increase with using MONSTER.

- 100% cleaning is not possible with the manual method. Slags remain at some certain points.
- Clean surface can be obtained with MONSTER.

- Manual Cleaning is exhausting for the operators which requires high effort.
- With MONSTER High Power lasers can be cleaned effortlessly.

- High safety risks -like injuries- exist during Manual Cleaning.
- No injury risks with MONSTER thanks to two hand Push & Go buttons.

3. Technical Specifications

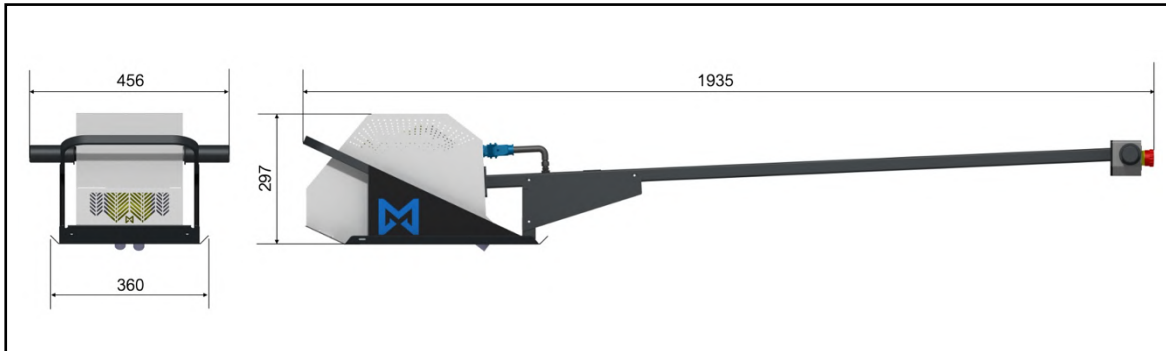

Item	Value
Production Code	
Voltage	220 VAC – Monophase
Frequency	50Hz - 60Hz
Motor Power	2,2 kW
Current	10 Amps
Weight	50 Kg
<p>Airborne Noise Emission</p> <p>During the operating condition of the MONSTER (while in use by moving the machine in normal speed and while in the stand-by) measured noise level of the workstation</p> <p>Use Ear Protection at all Times !</p>	<p>≤ 70 dB(A) ±3 dB(A)</p>
<p>Vibration Information</p> <p>During the operating condition of the MONSTER (while in use by moving the machine in normal speed and while in the stand-by) measured total value of vibrations to which the hand-arm system is exposed</p> <p>According to the measured level of vibrations, the operator is not allowed to use the MONSTER more than 5 hours / day</p>	<p>≤ 2,9 m/sec² ± 0,3 m/sec²</p>

The stated vibration emission might vary depending on the wear of the breakers or the maintenance level of the machine. If the machine is utilized for different applications, with different accessories, or poorly maintained, the vibration emission might fluctuate. It's crucial to choose the appropriate breakers and replace them periodically once they're worn out. Identify additional safety measures to safeguard the operator from the impacts of vibrations, such as maintaining the tool and accessories, keeping hands warm, and organizing work patterns.

1. Unboxing



Machine will be received in a wooden box. One wooden box can contain maximum two MONSTERS.



It is needed to be careful and equipped with protective clothes (gloves – shoes) for personal safety during unboxing the Monster.

Monster will be sent as in two pieces:

- Controlling Arm
- Monster Slag Cleaner Unit

It is needed to be assembled before usage by a qualified technician.

2. Assembling the Controlling Arm

**INFO**

Monster will be sent as in two pieces:

- Controlling Arm
- Monster Slag Cleaner Unit

It is needed to be assembled before usage by a qualified technician.

**WARNING**

It is needed to be equipped with protective clothes (gloves – shoes) for personal safety during Controlling Arm assembly.

**DANGER**

Do not plug-in the Main Power Supply Cable during assembly. It may cause electric shock or serious injury !

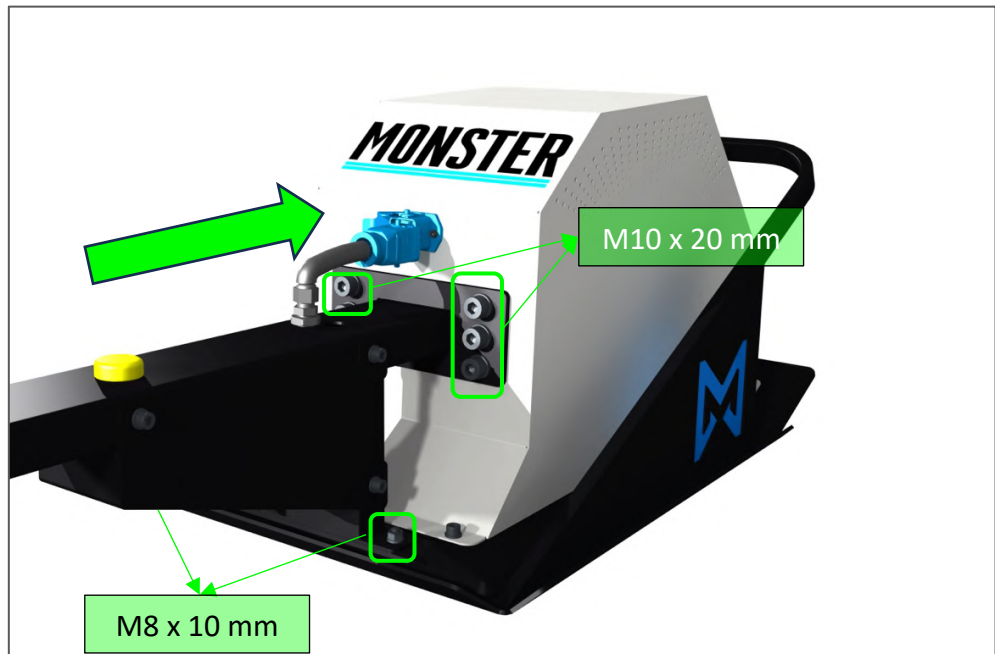
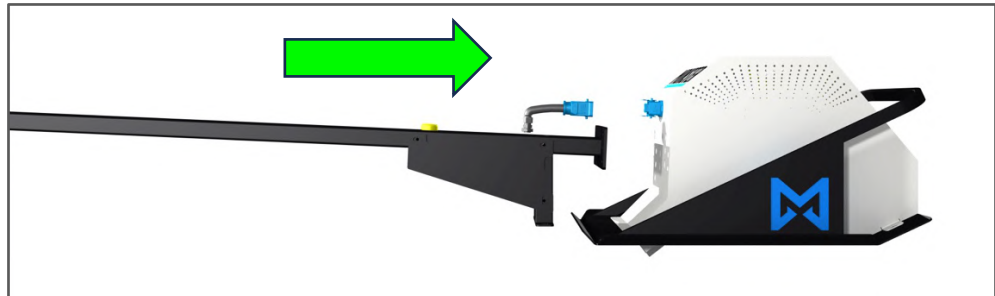

- 1- Plug-in the power socket.
- 2- Tighten the six bolts (M10 x 20mm) to the Cover.
- 3- Tighten the two bolts (M8 x 10mm) to the Under Cover Plate.

NOTE: All the bolts will be provided while sending Monster.

NOTE: It may be needed to lift-up the arm during screwing for a robust assembly.

3. Wheel Stand Take Off / Fixate



Wheel stand is designed for easy movement in the workshop. Also helps to keep Monster in standing position while not in use.

To take off the Wheel Stand, untightened the handles and pull off the wheel stand as shown below;

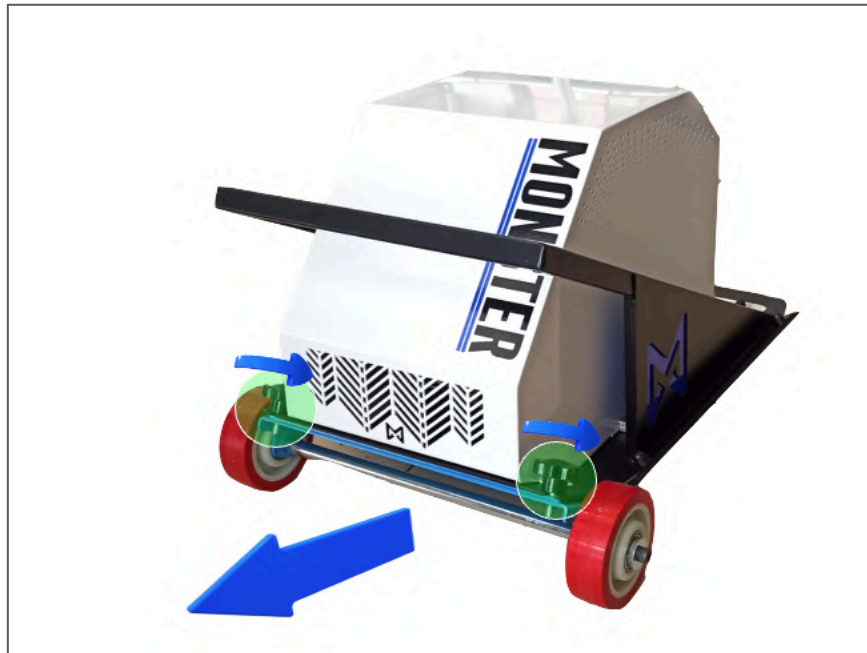

To fixate the Wheel Stand, put in the wheel stand and tightened the handles as shown below;

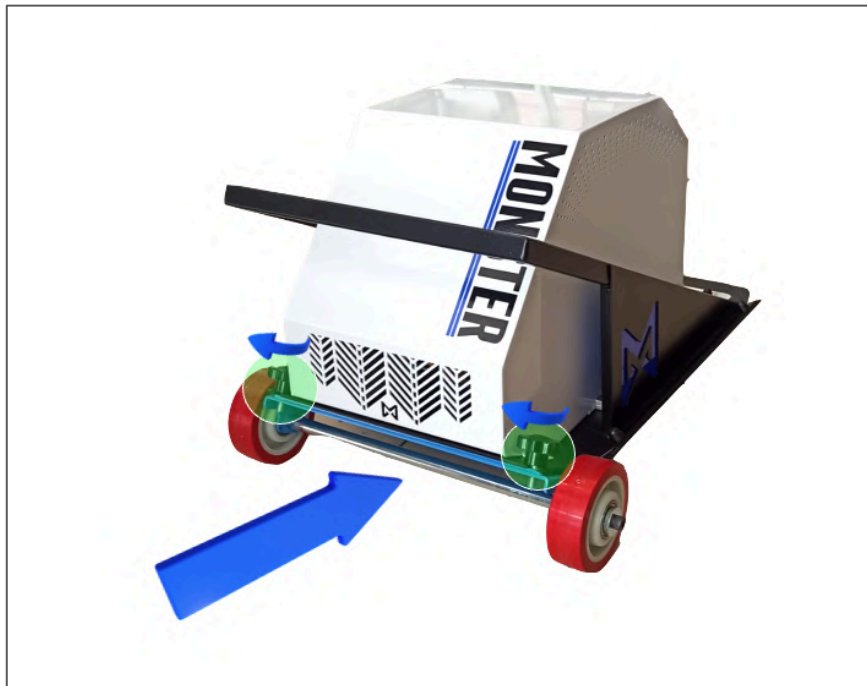

1. Switching ON the MONSTER



Follow below steps for Safe and easy cleaning with the Monster.



Wear always protective clothes, working shoes, ear plugs, gloves and glasses for personal safety.

1. Take Off the wheel stand on the ground.
2. Place the Monster on the Slats holding from front bar and the arm.



3. Plug in the power cable.



4. Stop Light automatically will be led as the machine is in stop position.



5. Press Start button to give a power to machine.



NOTE: There will be power in the system but machine will not start working until unless PUSH buttons are pressed at the same time.



WARNING

For personal safety and machine protection. Do not give a start to machine on the ground.



DANGER

It may cause serious operator injury if the breakers are in touch with the ground but not with the slats.

2. Operating / Cleaning with the MONSTER

**WARNING**

Wear always protective clothes, working shoes, ear plugs, gloves and glasses for personal safety.

For personal safety and machine protection. Do not give a start to machine on the ground.

**DANGER**

It may cause serious operator injury if the breakers are in touch with the ground but not with the slats.

1. To start cleaning, Press PUSH buttons while the green led is active. It needs to be pushed by two hands at the same time to run the machine.



2. Push FORWARD the machine to start cleaning of the slat.

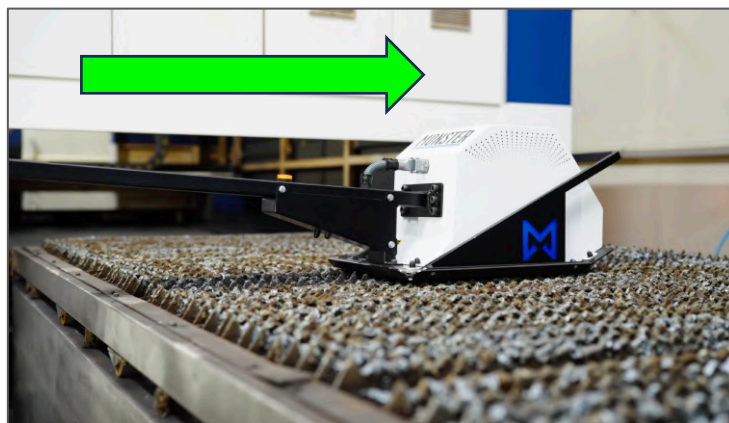

3. Once the slat is completely cleaned, push back the machine and switch to another slat to continue cleaning.
4. Repeat the same steps for all the slats.

NOTE: It is necessary to pay attention to the amount of the slag. The grater the slag amount will increase the cleaning time and the fatigue of the operator.

Thus, it is recommended to use MONSTER at least once in a week.

NOTE: Care should be taken to ensure that the slats are straight. Adequate efficiency cannot be obtained for cleaning the trapezoid slats. MONSTER does not work on slats that are warped due to cleaning with Hilti.



TIP: Due to high amount of slags, If the Monster is stacking during the cleaning;

Un-press the Push buttons and move the machine slightly upwards and downwards. Then press the push buttons again and continue cleaning.

This tip will help you to clean the slats faster and easier.

Also, this tip will protect the machine from over-heat and thermic fault.

3. Switching OFF the MONSTER

After completing the cleaning, follow below steps to switch OFF the machine;

1. Press STOP Button to shut down the machine.



2. Un-plug the machine
3. Take the machine to ground and put the wheel stand back.



NOTE: In case of any emergency situation during cleaning use the EMERGENCY STOP Button.

Once pressing the Emergency Stop Button, machine will be stopped and RED light will lit.

It is not possible to run the machine by the pressing the push buttons while the RED light is active.

Press Start button to de-activate the emergency situation and continue the cleaning.

4. Motor Overload Protection

Motor overload protection system is in place to protect the Monster engine from overheat and overloads.

In case of any over force during the cleaning, motor will stop itself automatically to protect the system.

If the machine stops due to motor overload, Yellow “Thermic Fault” light will lit as shown below:

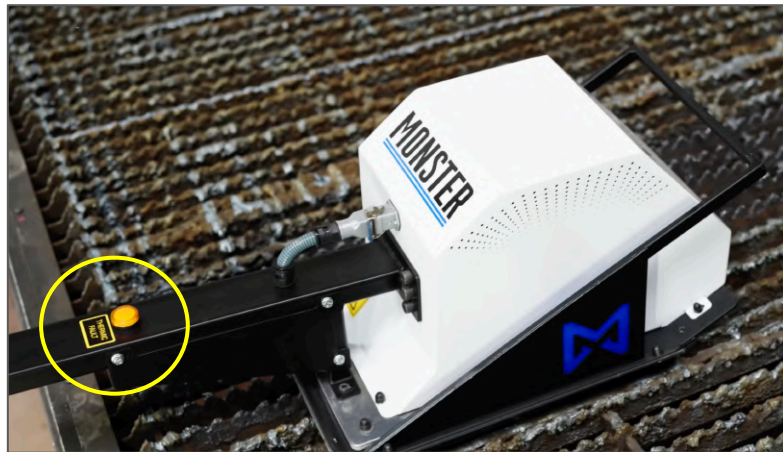

To deactivate the motor protection;

1. Turn the small cover above the yellow light
2. Put a screwdriver from the hole and press the button inside the Thermic Box.

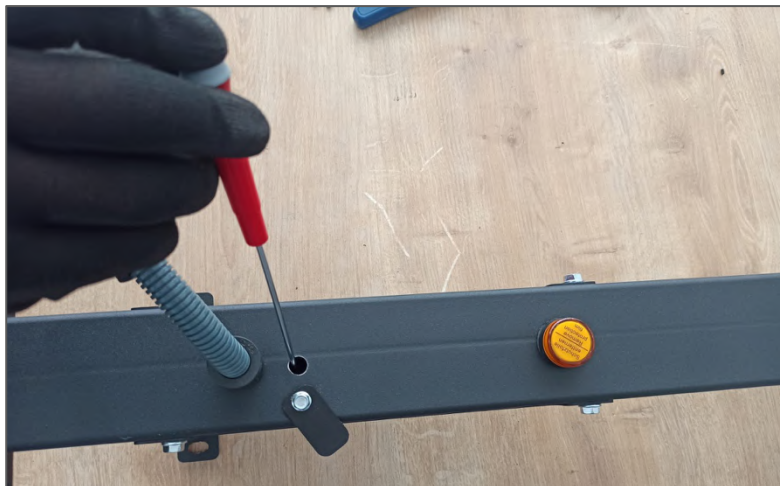

Unplug the machine before this operation and use a plastic screwdriver to eliminate the risk of electrical shock.



Unplug the power cable of machine before performing any maintenance activity. There is serious electrical shock injury risk.



All the maintenance activities should be carried out by a qualified technician to eliminate the injury risk due to incorrect maintenance and proper machine working.

1. Replacing the Breakers

Breakers are needs to be changed if there is a degradation on cleaning performance due to wearing on breakers.

Follow below steps to change the breakers;

1. Un-tightened the screws
2. Change the breakers with the new ones
3. Make sure that the sharp edges of the breakers are inline in the middle. If not, remove the breaker and turn on the other direction and assemble again.

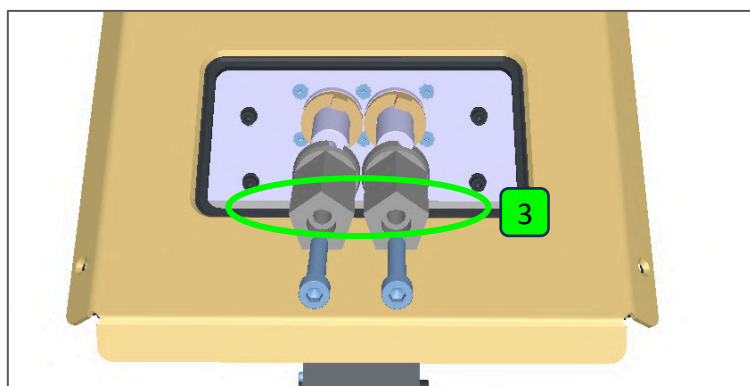
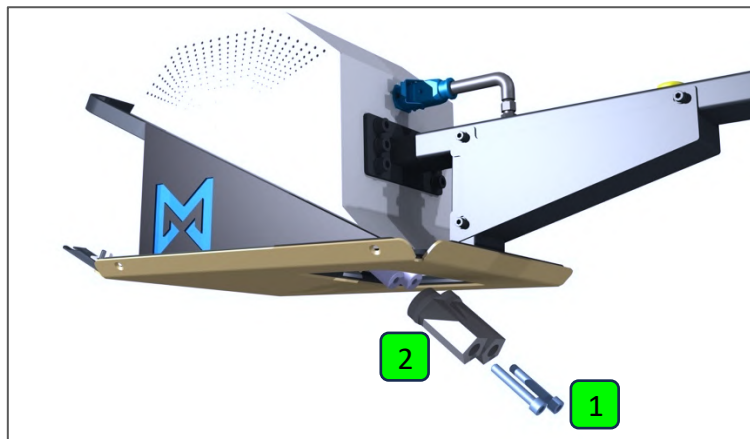

2. Replacing the Under Body Cover Plate

If the Under Body Cover Plate worn, it needs to be changed with the new one to increase the machine lifetime and to increase the cleaning performance.

Follow below steps to change the Under Body Plate:

1. Un-tightened the screws
2. Change the plate with the new
3. Tightened back the screws

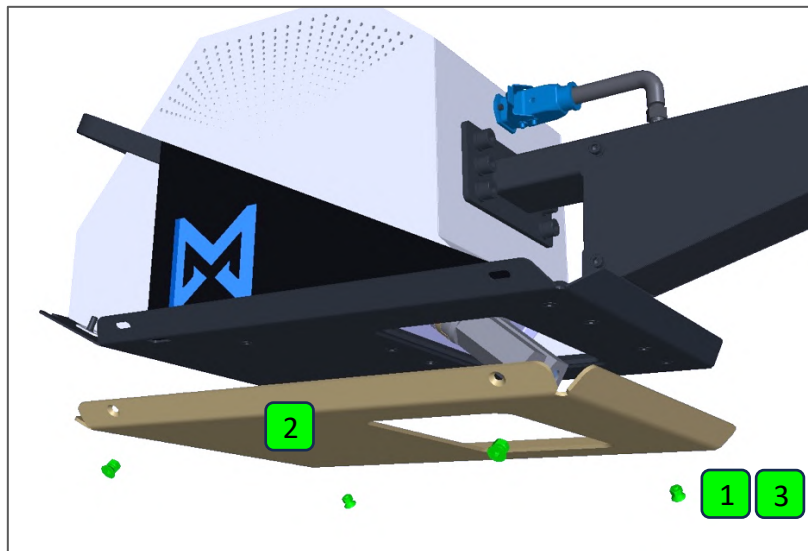

3. Replacing the Carbon Brushes

If there is a performance degradation on the motor like less torque, the carbon brushes need to be changed.

To change the brushes;

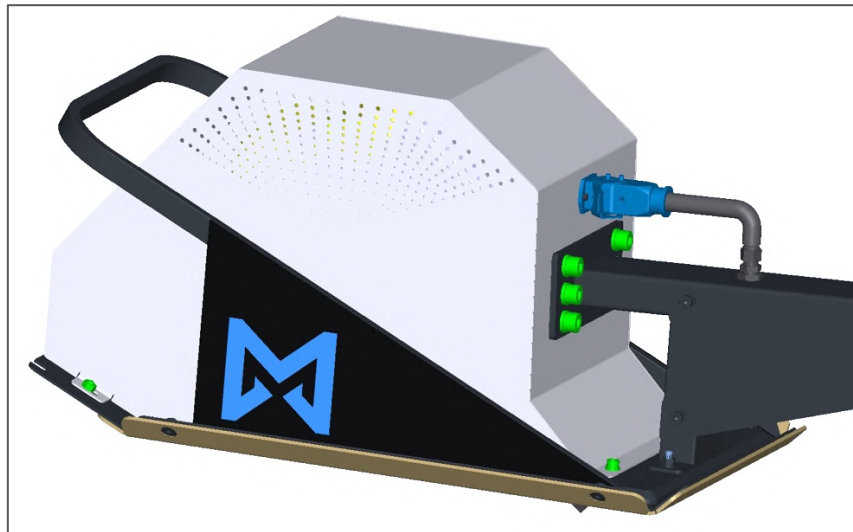

1. Remove the cover of Monster by untightened the green bolts
2. Change the brushes located underneath the motor
3. Re-assemble the cover.

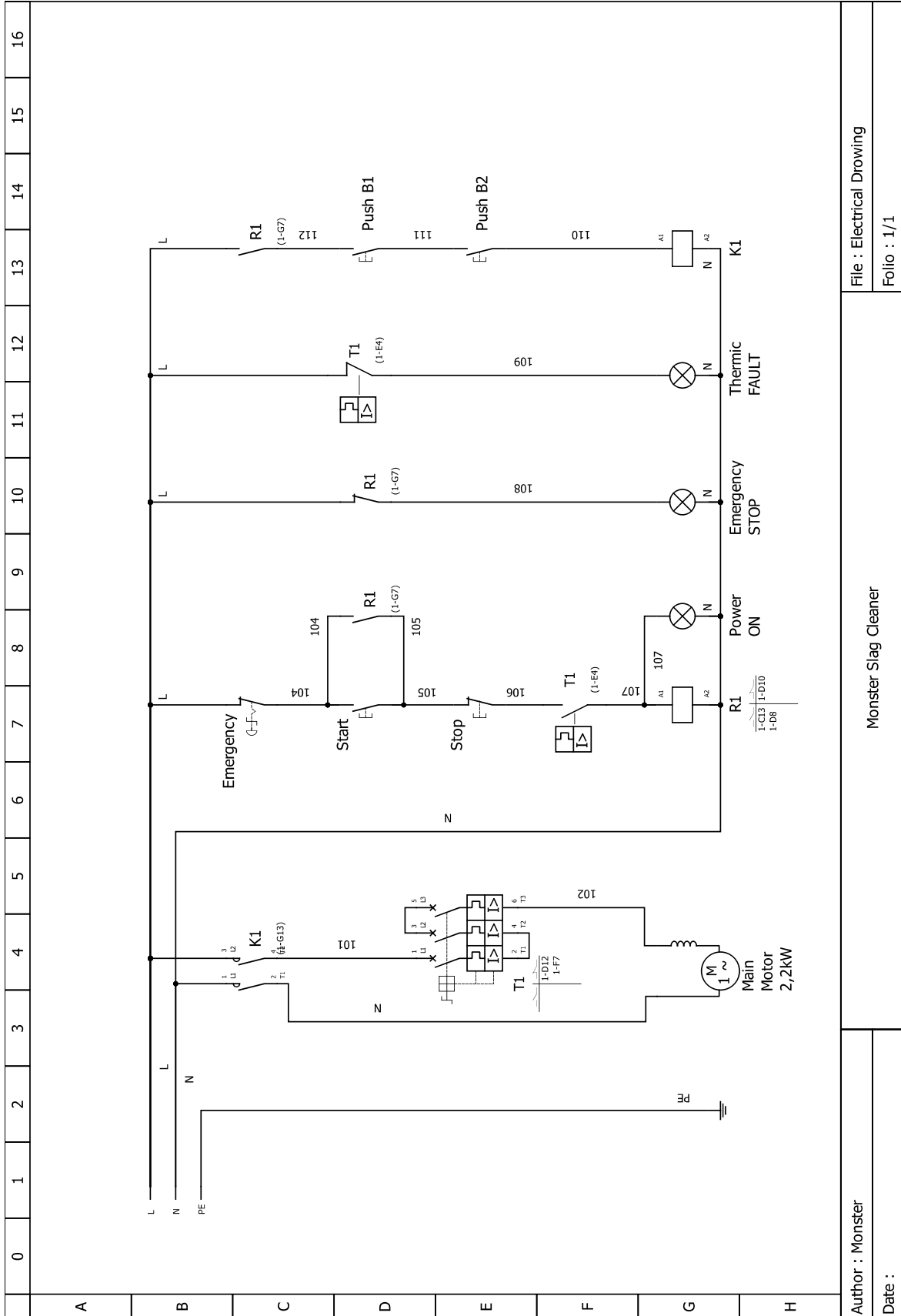

NOTE: For any other maintenance apart from the points listed above have to be performed by a qualified technician and it needs to be contacted with the manufacturer for further instructions.

4. Electrical Schema of MONSTER

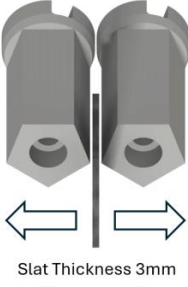
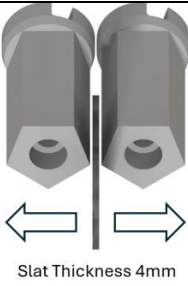
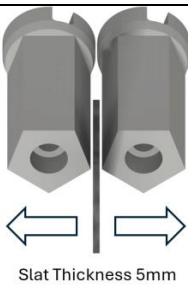
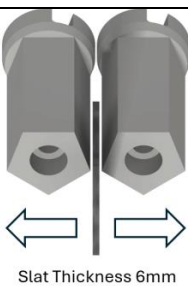

 <p>Slat Thickness 3mm</p>	<p>Breakers Type 3mm x 70mm</p> <p>Code : MS1-303</p>
 <p>Slat Thickness 4mm</p>	<p>Breakers Type 4mm x 70mm</p> <p>Code : MS1-304</p>
 <p>Slat Thickness 5mm</p>	<p>Breakers Type 5mm x 70mm</p> <p>Code : MS1-305</p>
 <p>Slat Thickness 6mm</p>	<p>Breakers Type 6mm x 70mm</p> <p>Code : MS1-306</p>
	<p>Under Body Cover Plate</p> <p>Code : MS1-015</p>

We declare that the document is issued under our sole responsibility and belongs to following product.

Product: Slag Cleaner Machine – MONSTER / M0101

Company: DORAY Makina Ltd. Şti.

Phone: +90 224 413 2182

Email: info@doraymakina.com

MOSNTER is designed for Laser Machine Slats Cleaning.
MONSTER has CE safety standard certificate.

Sign for and on behalf of:

Place of Issue

Nilüfer / BURSA / TURKIYE

Date of Issue

15 / 03 / 2024

Stamp & Signature

Yasemin İLERİ

Founder of Company



BENART Uluslararası Teknik Kontrol ve Belgelendirme Ltd. Şti.

İvedik OSB Melih Gökçek Bulvarı OSBTÜRK Plaza No:140/15 Yenimahalle/ANKARA/TÜRKİYE

Tel : +90 312 442 40 35 Fax : +90 312 442 40 32
www.benart.com.tr - info@benart.com.tr

UYGUNLUK SERTİFİKASI CERTIFICATE OF CONFORMITY

Firma Adı Company Name	: DORAY MAKİNA SANAYİ VE TİCARET LİMİTED ŞİRKETİ		
Adres Address	: ALAADDİNBEY MAHALLESİ 637. SOKAK İŞ YERLERİ SİTESİ NO:71 NİLÜFER BURSA / TÜRKİYE		
Ürün Tanımı Product Description	: CÜRUF TEMİZLEME MAKİNASI SLAG CLEANER MACHINE		
Ürün Markası/Tipi Product Brand/Type	: MONSTER/M0101, M0102, M0103		
Referans Yönetmelik(ler) Reference Directive(s)	: 2006/42/AT Makine Emniyet Yönetmeliği Ek-1 2006/42/EC Machinery Directive Annex-1		
Referans Standart(lar) Reference Standard(s)	: EN ISO 12100:2010, EN 60204-1:2018		
Test Raporu Test Report	: Benart Uluslararası Teknik Kontrol Ve Belgelendirme Ltd.Şti. : LVD-5967		
Sertifika No Certificate No	: 2448		
Yayın Tarihi Issue Date	: 15.03.2024	Geçerlilik Tarihi Expiry Date	: 14.03.2025

BENART Uluslararası Teknik Kontrol ve Belgelendirme Ltd. Şti., yukarıda adı ve adresi belirtilen firmadan, ürün teklifini yapmış, ürüne ilişkin sunduğu dokümantasyonu yukarıda belirtilen referans yönetmelik ve / veya referans standartları göre incelemiştir. Yönetmeliğe ve standartlara göre ürünü ve dokümantasyonun uygunluğu firma sorumluluğundadır. Ancak yukarıda belirtilen yönetmelik ve / veya referans standartları, ürünün birden fazla yönetmeliğe ve

standartta tabii olması durumunda diğer yönetmeliklerin ve standartların şartlarını da firma yerine getirdiğinde **CE** uygunluk işaretini ürün üzerine iştirebilir ve uygunluk beyanı düzenleyebilir. Bu sertifika BENART'ın Onaylanmış Kuruluş kimliği altında düzenlenmemiştir. Bu sertifika teknik sonucunun olumlu olması sebebi ve firma talebi üzerine düzenlenmiştir.

BENART International Technical Control and Valuation Inc. has made technical inspection of product, inspected the documentation presented concerning the product of the company whose name and address mentioned above according to the reference directive and/or reference standards. Suitability of product and documentation to the directive and standards are under the responsibility of the company. However, in case the product is subject to more than one of the directives and standards which are

mentioned above, when the company fulfills conditions of other directives and standards, then it can attach **CE** conformity marking and arrange conformity declaration. This certificate has been issued as per company request. This certificate has not been issued under Notified Body identity. This certificate has been issued upon the request of the company and the result of the examination is positive.

Genel Müdür / General Manager



Bu belgenin mülkiyet hakkı BENART Uluslararası Teknik Kontrol ve Belgelendirme Ltd. Şti.'ne aittir ve istenildiğinde iade edilmelidir. BENART bir sonraki kontrol tarihi için belge basım tarihinden 1 yıl sonrası tavsiye eder. Bu belgenin geçerliliği BENART ile iletişime geçilerek sorgulanabilir.

The property rights to this document belong to BENART International Technical Control and Valuation Inc. and it has to be returned when requested. BENART recommends one year later following the document issue date for the date of next control. The validity of this document can be questioned by contacting BENART.

DORAY MAKİNA SANAYİ VE TİCARET LİMİTED ŞİRKETİ guarantees the MONSTER SLAG CLEANER and its components for a period of 2 years from the date of delivery against the design, material defects used in manufacturing. Any malfunctions within the scope of warranty that may occur within this period will be repaired as free of charge as soon as possible (provided that it does not exceed 30 working days). Warranty is limited to the parts provided by DORAY MAKİNA SANAYİ VE TİCARET LİMİTED ŞİRKETİ. The robot used in the system and belongings to the buyer is not included in this warranty.

Unless otherwise, the issues that are not covered by the 2-year warranty are as follows:

- 1- Malfunctions resulting from incorrect use other than those specified in the instructions for use.
- 2- Malfunctions arising from the lack of proper electrical installation by the user and the lack of electricity at the appropriate voltage and frequency.
- 3- Malfunctions caused by assembly errors, if the assembly is made by the user.
- 4- Operation of the defective source cell and the growth of the fault and / or the emergence of new faults for this reason.
- 5- Failures that occur as a result of changing the safety automatics and setting parameters in the system, not adjusting to the required values, not being used and / or as a result.
- 6- Malfunctions resulting from the operation of the machine or attempting to operate it outside the conditions specified in the operating instructions.
- 7- Malfunctions resulting from failure or incorrect performance of the periodic maintenance specified in the instructions for use.
- 8- Intervention to the machine by people other than our authorized services, outside of the authorized limits.

Failure of the machines due to the above reasons will immediately terminate the free warranty of DORAY MAKİNA SANAYİ VE TİCARET LİMİTED ŞİRKETİ. The warranty covers the repair of the defective part or, if this is not possible, the replacement with a new one. Replacing the part that is found to be defective does not mean replacing the welding cell. Parts replaced under warranty are covered by warranty within 3 months from the date of replacement. The warranty application does not give the customer any right to claim any compensation. Malfunctions that may occur in the conditions stated above and / or after the expiry of the warranty period will be repaired as soon as possible in return for the fee of DORAY MAKİNA SANAYİ VE TİCARET LİMİTED ŞİRKETİ. The determination of whether a malfunction is within the scope of the warranty should be made by the personnel of DORAY MAKİNA SANAYİ VE TİCARET LİMİTED ŞİRKETİ or the person or persons authorized by it.



MONSTER SLAG CLEANER USER MANUAL 2024_V1



DORAY MAKİNA SAN. Ve TİC. TLD. ŞTİ.
Alaaddinbey Mah. 637. Sokak
İşyerleri Sitesi No:7/1
NİLÜFER – BURSA – TÜRKİYE
Phone: +90 224 413 2182
info@doraymakina.com
www.doraymakina.com